

VISTA FRONTALE

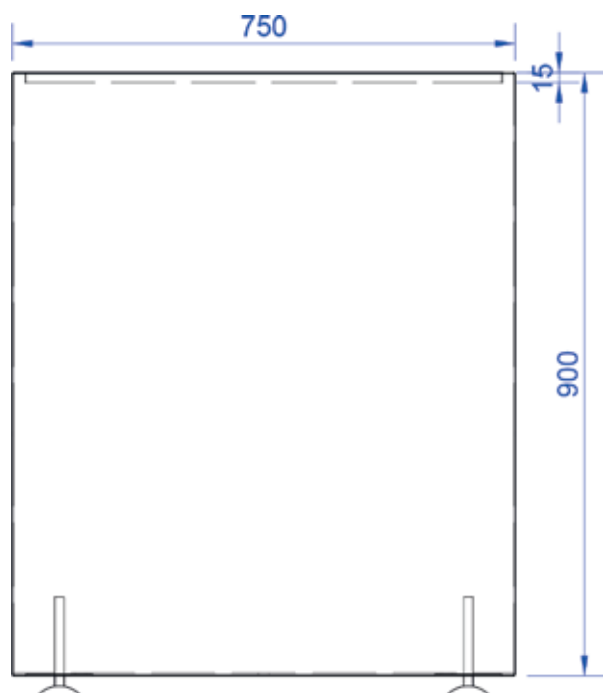

VISTA SUPERIORE

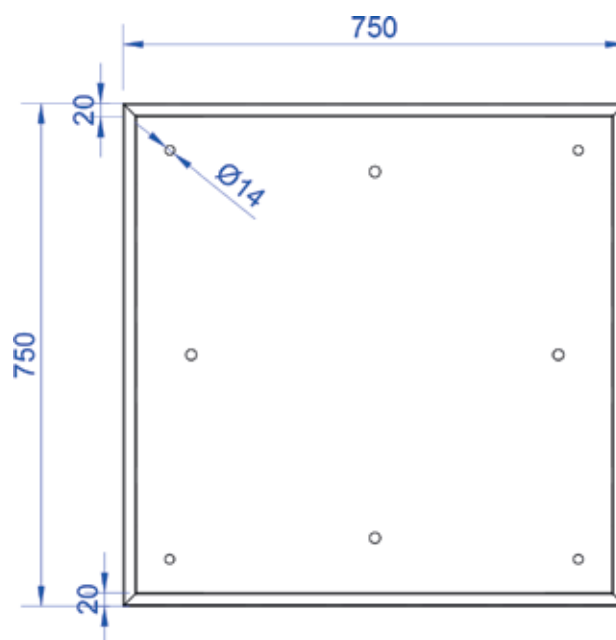

SPECIFICHE TECNICHE

ALTEZZA (MM)	900
LARGHEZZA (MM)	750
PROFONDITA' (MM)	750
DIAMETRO (Ø)	/

Fioriera a pianta quadra realizzata in metallo con trattamento di verniciatura a polveri elettrostatiche. Quest'ultima presenterà dei piedini di livellamento per la regolazione delle pendenze.

COLORI



FINITURE

